

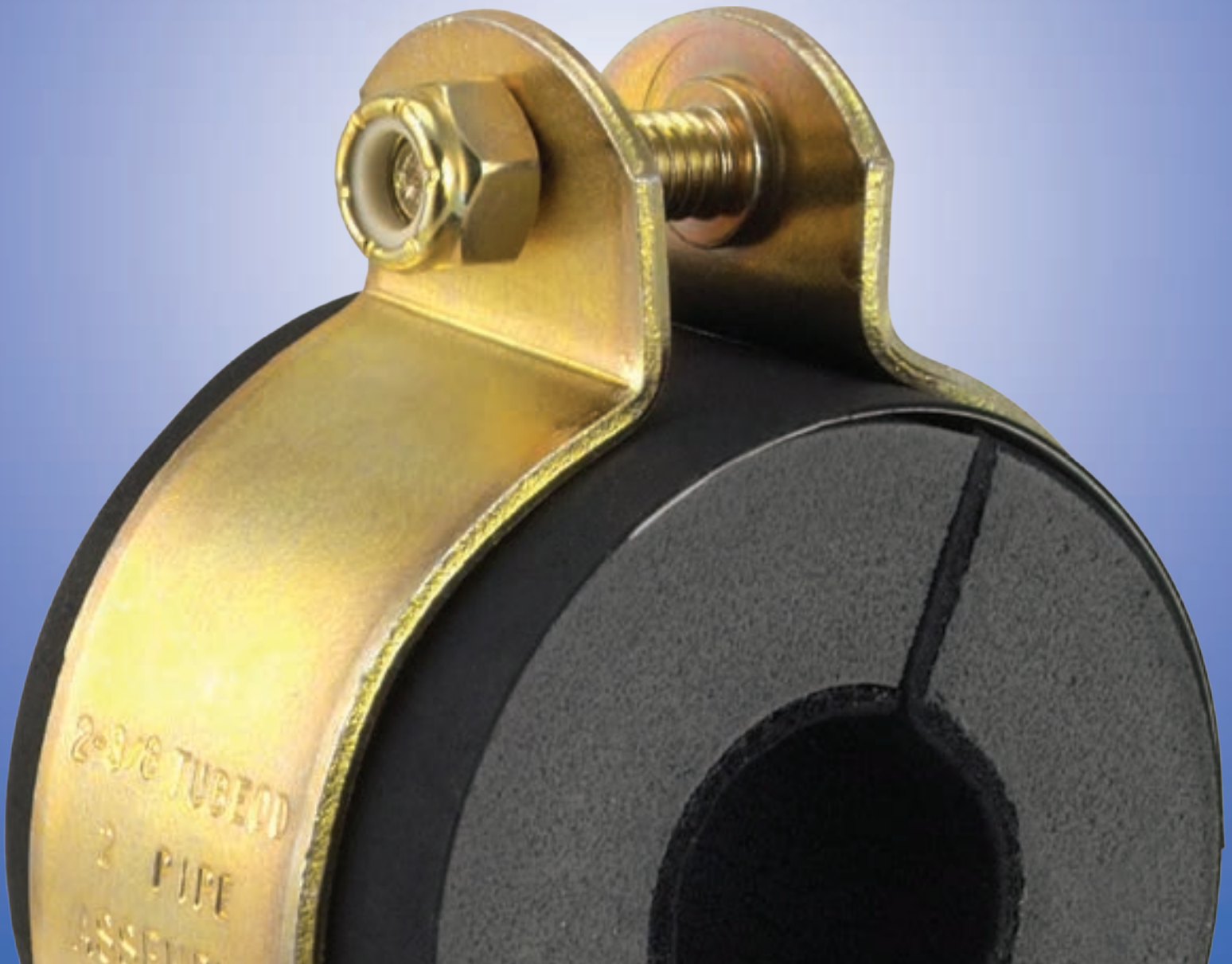

ZSI-Foster



CUSH-A-THERM™
VAPOR BARRIER PROTECTION



www.zsi-foster.com



AIRTIGHT CRUSH-RESISTANT INSULATION CLAMP

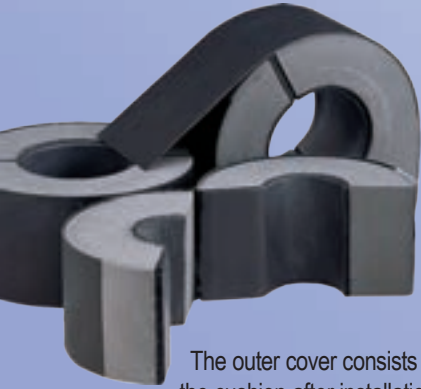

Cush-A-Therm™ Clamp is a perfect crush-resistant airtight seal for chilled refrigeration or mechanical pipe lines that require continuous insulation.

The rigid foam construction has an insulating tape inner lining which supports tube and absorbs vibration of operating pipe lines.

The outer cover consists of a special rubber coating which seals the cushion after installation in order to prevent condensation.

Its strong closed-cell structure is ideal for liquid cooling lines to prevent condensation, save energy, and maintain the vapor barrier.



FEATURES

- Temperature range: -70°F to +250°F (-200°C to +125°C)
- Flammability is Self-Extinguishing as tested under ASTM D 635
- Maintains thermal barrier protection
- Prevents condensation
- Properly supports pipe and tube
- Absorbs vibration
- Polyurethane foam laminated with a rubber lining
- UV resistance rated as Excellent as tested under ASTM G7

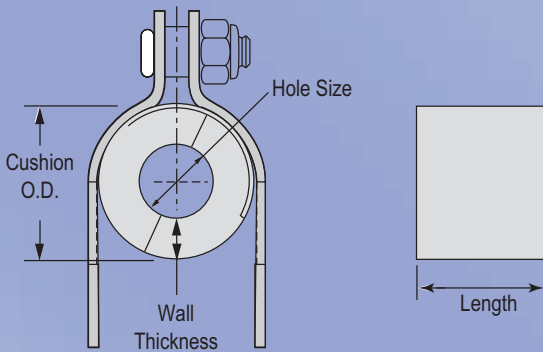

NOTE: Complete assembly supplied with gold electro-galvanized channel clamp and hardware

Dimensions (Inches)					Nominal 1/2" Wall Thickness		Nominal 3/4" Wall Thickness		Nominal 1" Wall Thickness		Nominal 1-1/2" Wall Thickness		Nominal 2" Wall Thickness	
Hole Size	Copper I.D.	Pipe O.D.	IPS	Length	Part No.	Cushion O.D.	Part No.	Cushion O.D.	Part No.	Cushion O.D.	Part No.	Cushion O.D.	Part No.	Cushion O.D.
1/4 ID	-	1/4"	-	2.953"	UX1412	1.250"	UX1434	1.750"	UX1410	2.250"	-	-	-	-
3/8 ID	1/4"	3/8"	-	2.953"	UX3812	1.375"	UX3834	1.875"	UX3810	2.375"	UX3815	3.375"	-	-
1/2 ID	3/8"	1/2"	1/4"	2.953"	UX1212	1.500"	UX1234	2.000"	UX1210	2.500"	UX1215	3.500"	-	-
5/8 ID	1/2"	5/8"	3/8"	2.953"	UX5812	1.625"	UX5834	2.125"	UX5810	2.625"	UX5815	3.625"	UX5820	4.625"
3/4 ID	5/8"	3/4"	-	2.953"	UX3412	1.750"	UX3434	2.250"	UX3410	2.750"	UX3415	3.750"	UX3420	4.750"
7/8 ID	3/4"	7/8"	1/2"	2.953"	UX7812	1.875"	UX7834	2.375"	UX7810	2.875"	UX7815	3.875"	UX7820	4.875"
1-1/8 ID	1"	1-1/8"	3/4"	2.953"	UX11812	2.125"	UX11834	2.625"	UX11810	3.125"	UX11815	4.125"	UX11820	5.125"
1-3/8 ID	1-1/4"	1-3/8"	1"	2.953"	UX13812	2.375"	UX13834	2.875"	UX13810	3.375"	UX13815	4.375"	UX13820	5.375"
1-5/8 ID	1-1/2"	1-5/8"	1-1/4"	2.953"	UX15812	2.625"	UX15834	3.125"	UX15810	3.625"	UX15815	4.625"	UX15820	5.625"
1-7/8 ID	-	1-7/8"	-	2.953"	UX17812	2.875"	UX17834	3.375"	UX17810	3.875"	UX17815	4.875"	UX17820	5.875"
2-1/8 ID	2"	2-1/8"	-	2.953"	UX21812	3.125"	UX21834	3.625"	UX21810	4.125"	UX21815	5.125"	UX21820	6.125"
2-3/8 ID	2-1/4"	2-3/8"	2"	2.953"	UX23812	3.375"	UX23834	3.875"	UX23810	4.375"	UX23815	5.375"	UX23820	6.375"
2-5/8 ID	2-1/2"	2-5/8"	-	3.937"	UX25812	3.625"	UX25834	4.125"	UX25810	4.625"	UX25815	5.625"	UX25820	6.625"
2-7/8 ID	-	2-7/8"	2-1/2"	3.937"	UX27812	3.875"	UX27834	4.375"	UX27810	4.875"	UX27815	5.875"	UX27820	6.875"
3-1/8 ID	3"	3-1/8"	-	3.937"	UX31812	4.125"	UX31834	4.625"	UX31810	5.125"	UX31815	6.125"	UX31820	7.125"
3-1/2 ID	-	3-1/2"	3"	3.937"	UX31212	4.500"	UX31234	5.000"	UX31210	5.500"	UX31215	6.500"	UX31220	7.500"
3-5/8 ID	3-1/2"	3-5/8"	-	3.937"	UX35812	5.625"	UX35834	5.125"	UX35810	5.625"	UX35815	6.625"	UX35820	7.650"
4-1/8 ID	4"	4-1/8"	3-1/2"	3.937"	UX41812	5.125"	UX41834	5.625"	UX41810	6.125"	UX41815	7.125"	UX41820	8.125"



AIRTIGHT CRUSH-RESISTANT INSULATION CLAMP

INSTALLATION IS AS EASY AS 1-2-3!



1. Insulation slides over pipes.
Self adhesive surfaces provide seal.

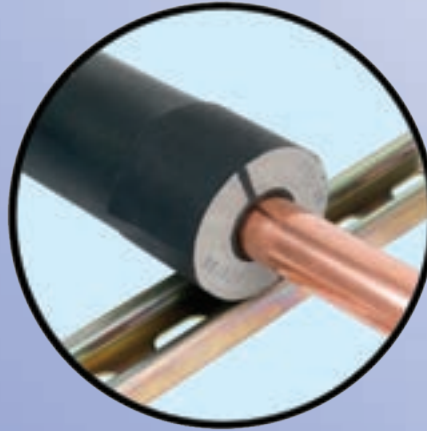

2 Put in place and glue to insulation.



3. Wrap and seal with ProTape.

Cush-A-Therm

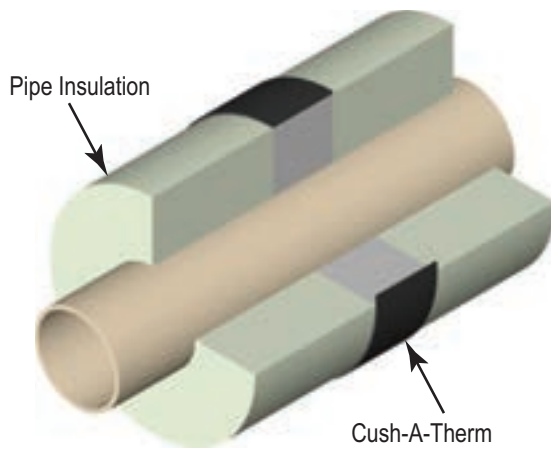

Pipe Insulation

Cush-A-Therm

Insulation Glued to Cush-A-Therm
which Avoids Air Space and Loss of Insulation

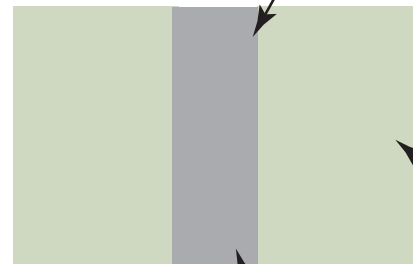

Pipe Insulation

Only Insulation Contacts Pipe
no Thermal Conductor

v.s. Plastic Alternative

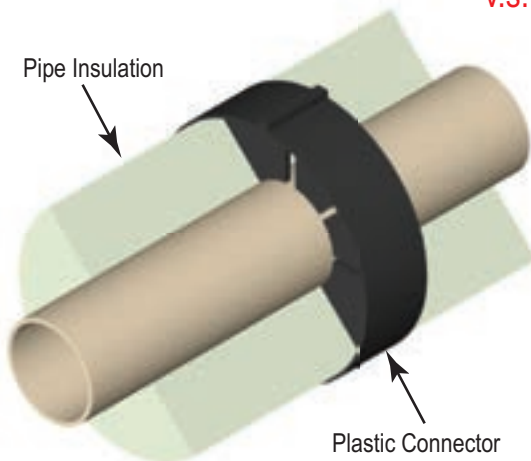

Pipe Insulation

Plastic Connector

Air Space (loss of insulation)

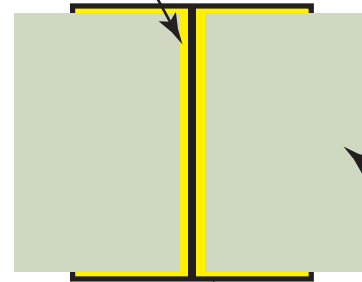

Pipe Insulation

Plastic Connector is Thermal Conductor



CUSH-A-CLAMP®

Cush-A-Clamp® –Channel mounted clamping systems are ideal for multiple line runs, while absorbing shock and vibration, reducing

unwanted noise and preventing galvanic corrosion.

Cush-A-Clamp® fits any standard 1-5/8" wide channel. The clamp features a unique shoulder stud which is securely fastened to one clamp half. Steel clamps for tube sizes up to 1-3/8" have the "Controlled Squeeze™" design which eliminates over-tightening and rotation while a nylon-insert nut assures a positive lock.

OMEGA SERIES™

Omega Series™ – The Omega Series™ clamp assembly retains, guides, protects line runs. Attached with two standard fasteners to any flat surface, the clamp eliminates the use of special channels, providing a savings in both space & cost. The cushion is manufactured from a thermoplastic elastomer, it's built tough to withstand the effects of most oils, chemicals and industrial cleaning compounds.



CAL-CLAMP INSULATION

The **Cal-Clamp** is a crush-resistant insulation clamp. Works equally well on both hot and cold lines. The Cal-Clamp includes the strut clamps required for installation. Asbestos Free Calcium Silicate, treated for water resistance, encased in a 360° A-653 Galvanized Sheet Metal jacket



LOOP CLAMPS

Clamps that can be slipped over a tube or wire and closed with a bolt at assembly. Holes provide easy alignment. E.P.D.M. cushion for electrical insulation and vibration absorption. The steel clamps are zinc electroplated for corrosion resistance



CUSH-A-CLAW™

The **Cush-A-Claw™** Grabs your Tube, Pipe, or Hose and holds it in place. The unique one piece patent pending design allows for quick, and simple installation. It will not rust because it's molded from the same TPE Material of some of our other products that you've come to know and trust.



ALPHA SERIES™

Alpha Series™ – Designed for the tough jobs, the Alpha Series™ U-Bolt Assembly secures pipe runs to any flat surface. The cushion designed provides total load distribution, allowing the U-Bolt to become a full contact hanger, eliminating knife-edge loading. The U-Bolt traps and secures the cushion in place to prevent lateral movement, while nylon insert locknuts provide a positive lock.



CUSH-A-CLICK

The **Cush-A-Click** is ideal for the installation of refrigeration systems allowing the barrier seal to run the length of the pipe work without cutting the insulation material. It helps retain an unbroken vapor barrier seal, eliminating the problem of sweating on metal fittings.



SADDLE-UP

The **Saddle-Up** Pipe Insulation Saddle is a formed metal shield designed to allow insulated refrigeration pipe or tubing to pass through the support without need to compromise the vapor barrier and protects from crushing or damage at hanger and support locations.



DISTRIBUTED BY:



ZSI, INC.

45065 Michigan Ave.
Canton, MI 48188
Tel: (734) 844-0055
Tel: (800) 323-7053
Fax: (734) 844-0066